



CAAC Design and Construction Update

11-16-2023



2024 Bond Projects

Meyers Pool

City of Arvada / Jeffco / Apex
OLC Designs – Saunders CMGC

Construction



Efficiency Future Ready Wheat Ridge HS Eidos – GTC

Construction
Resumes
March 2024



Efficiency Future Ready
Wheat Ridge HS
Eidos – GTC

Construction
Resumes
March 2024



Drake MS – Efficiency Future Ready MOA – Calahan

Construction

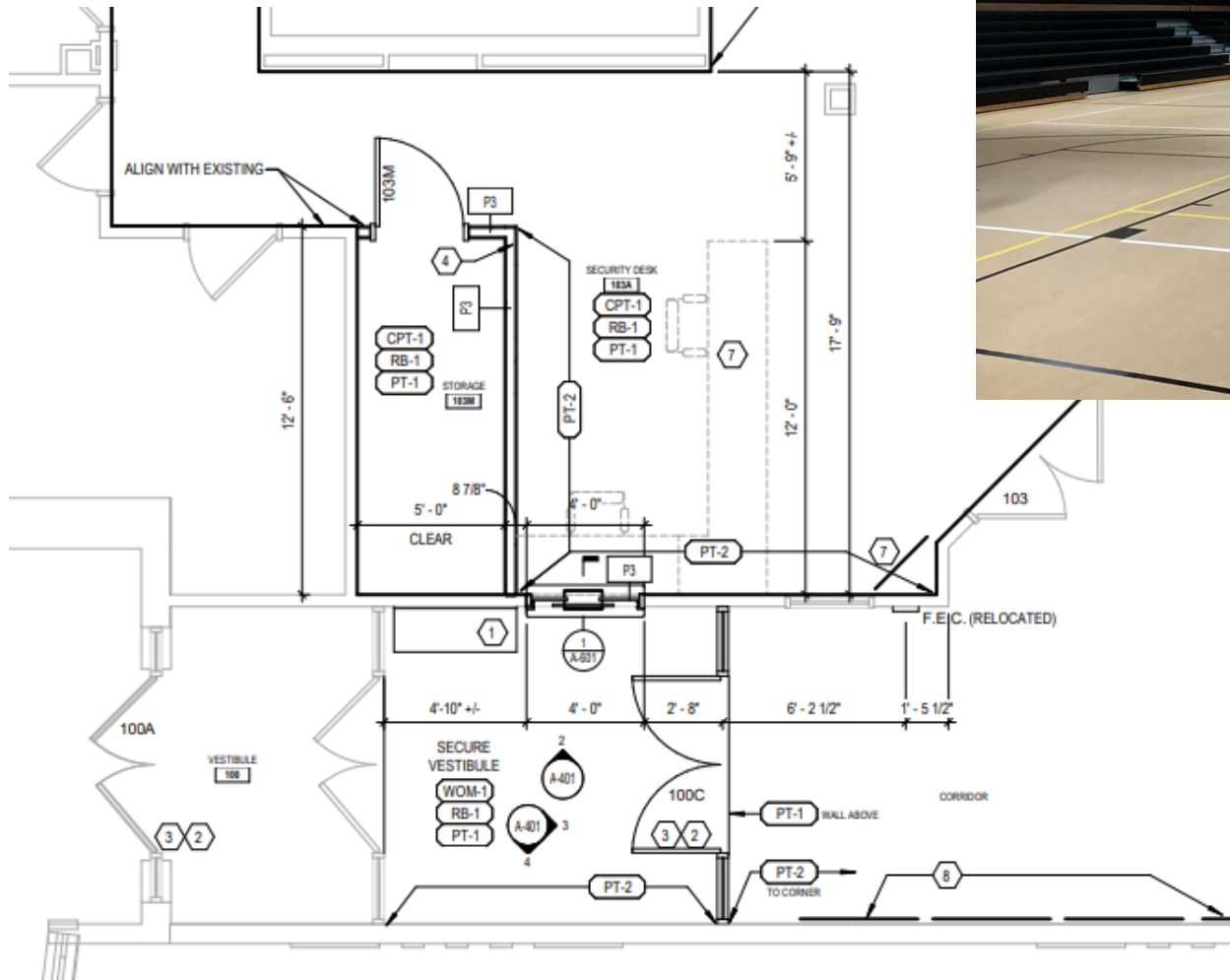

Weber ES – Efficiency Future Ready MOA – Saunders

Construction

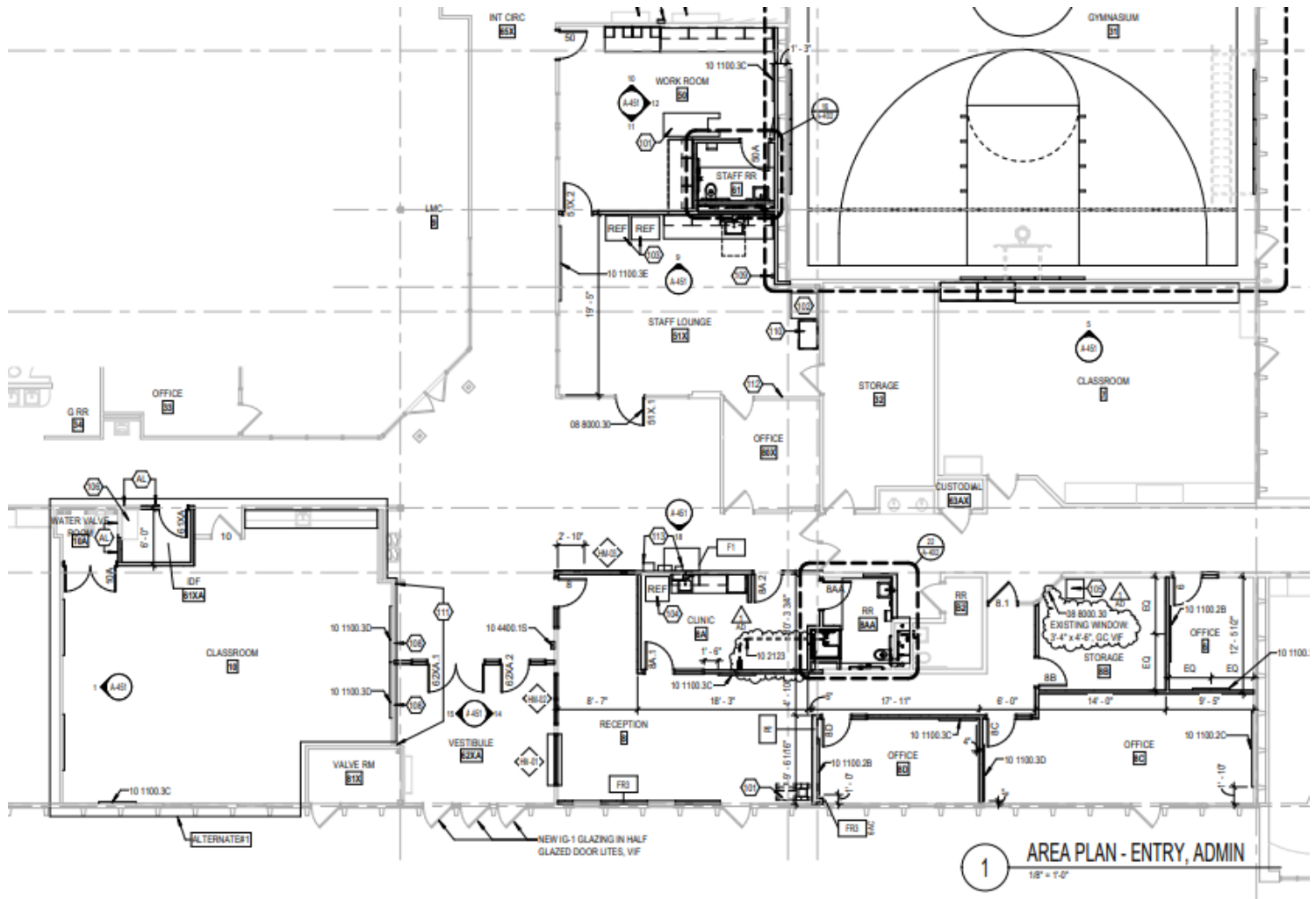

1 AREA PLAN - ENTRY, ADMIN
18' x 7'-0"



Meiklejohn ES – Efficiency Future Ready H&M – McCauley

Construction

SCHEMATIC PLAN

- A LOCKED DOOR W/ ENTRY CONTROL
- B UNLOCKED ENTRY DOOR
- C SECURE TRANSACTION WINDOW
- D LOCKED DOOR W/ ENTRY CONTROL
- E DOOR TO RECEPTION
- - - -> PATH OF TRAVEL
- SECURITY CHECKPOINT
- WORKSTATION

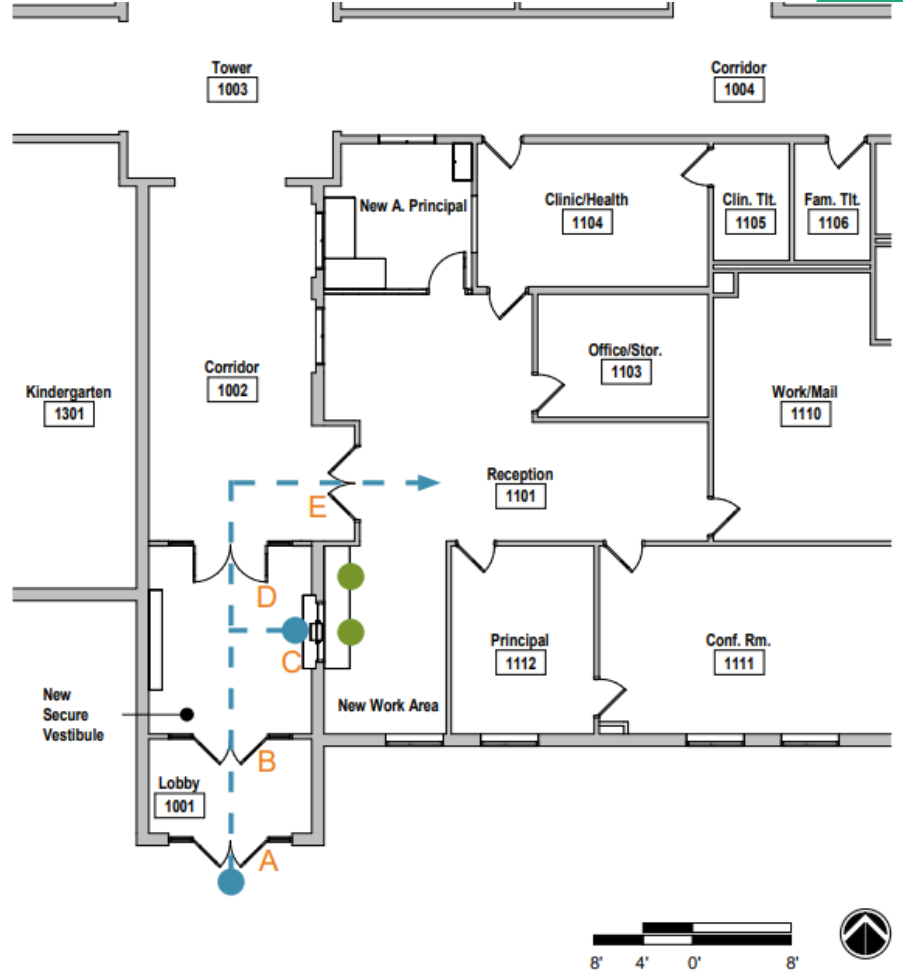

SCHEMATIC PLAN

- A LOCKED DOOR W/ ENTRY CONTROL
- B SECURE TRANSACTION WINDOW
- C LOCKED DOOR W/ ENTRY CONTROL
- D DOOR TO RECEPTION W/ CARD READER
- - - - -> PATH OF TRAVEL
- SECURITY CHECKPOINT
- WORKSTATION



Fairmount ES – Efficiency Future Ready Eidos / Cator Ruma – GTC

Construction

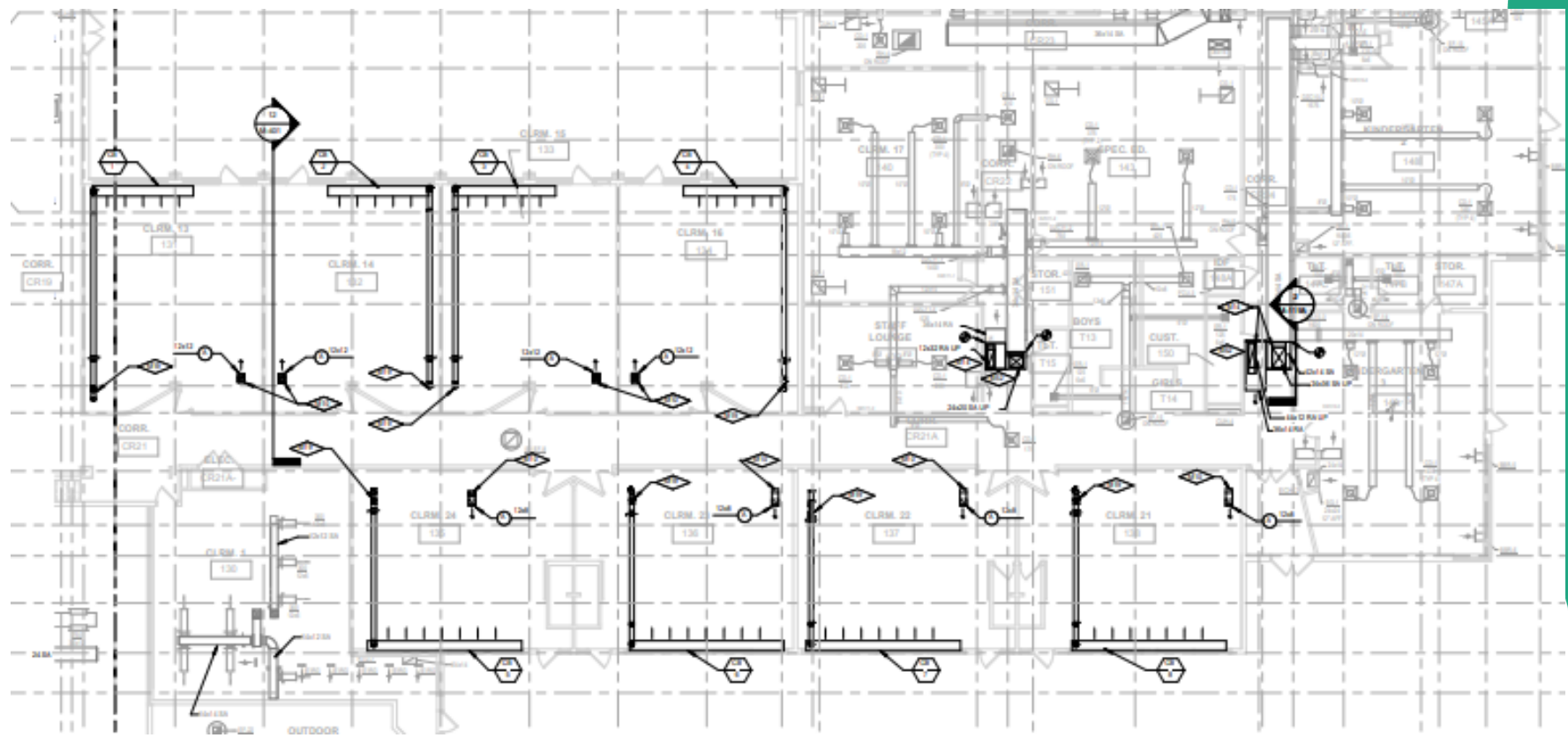

Evergreen HS – Pump House H&M – Single Track

Construction

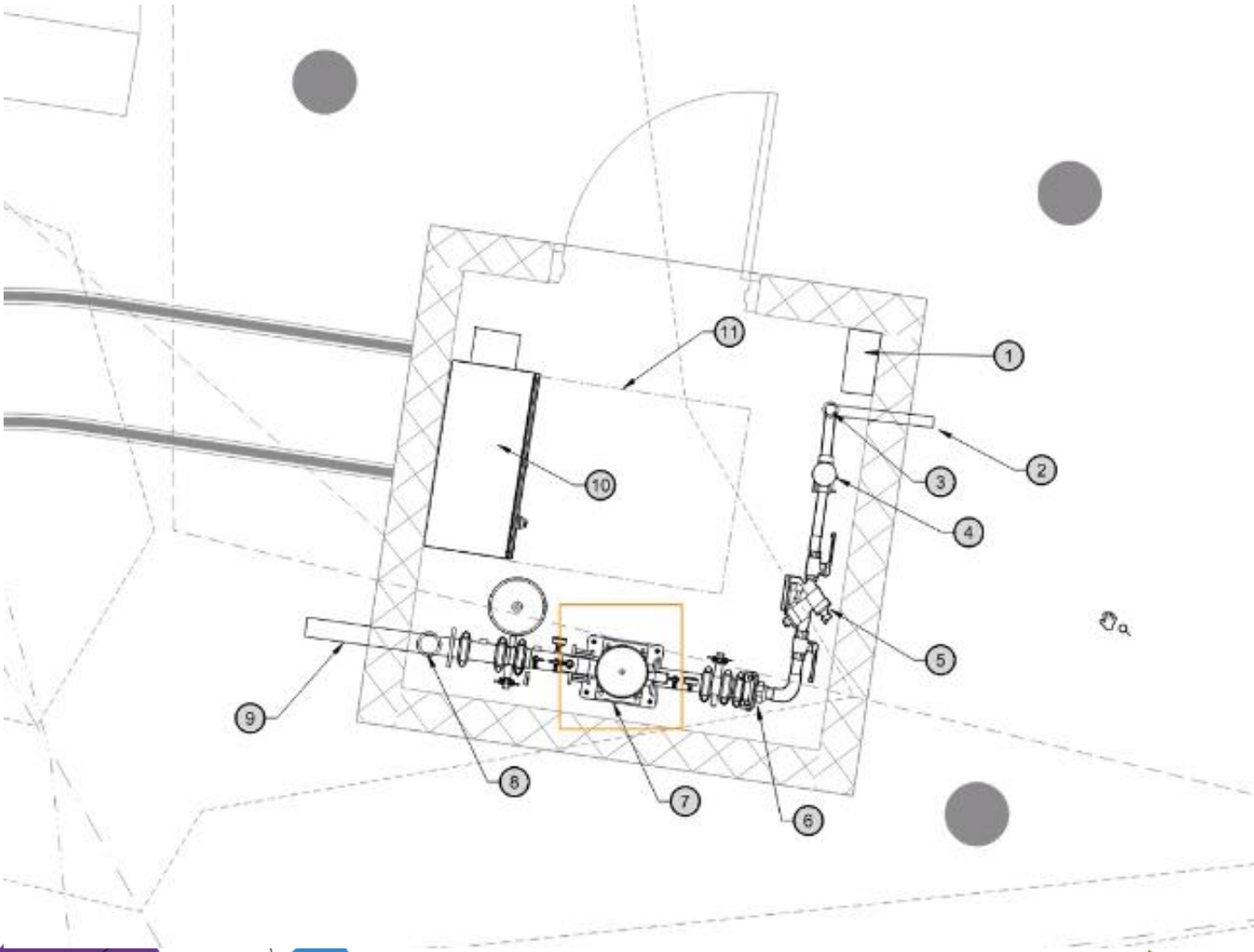

Parmalee ES – Admin Ventilation OZ – Single Track

Construction

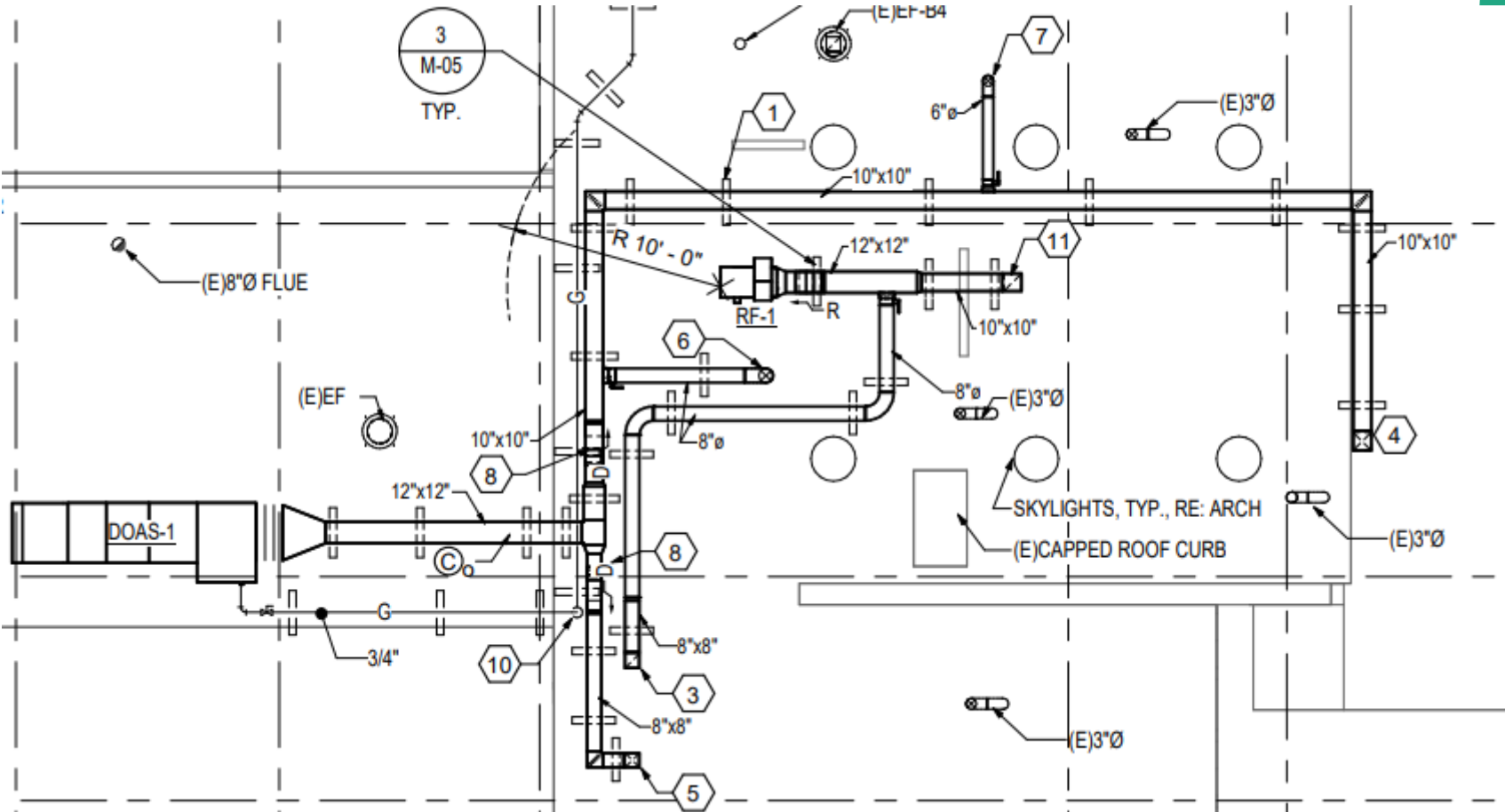

Bradford North – Efficiency Future Ready MOA – TBD

Bids
11/30

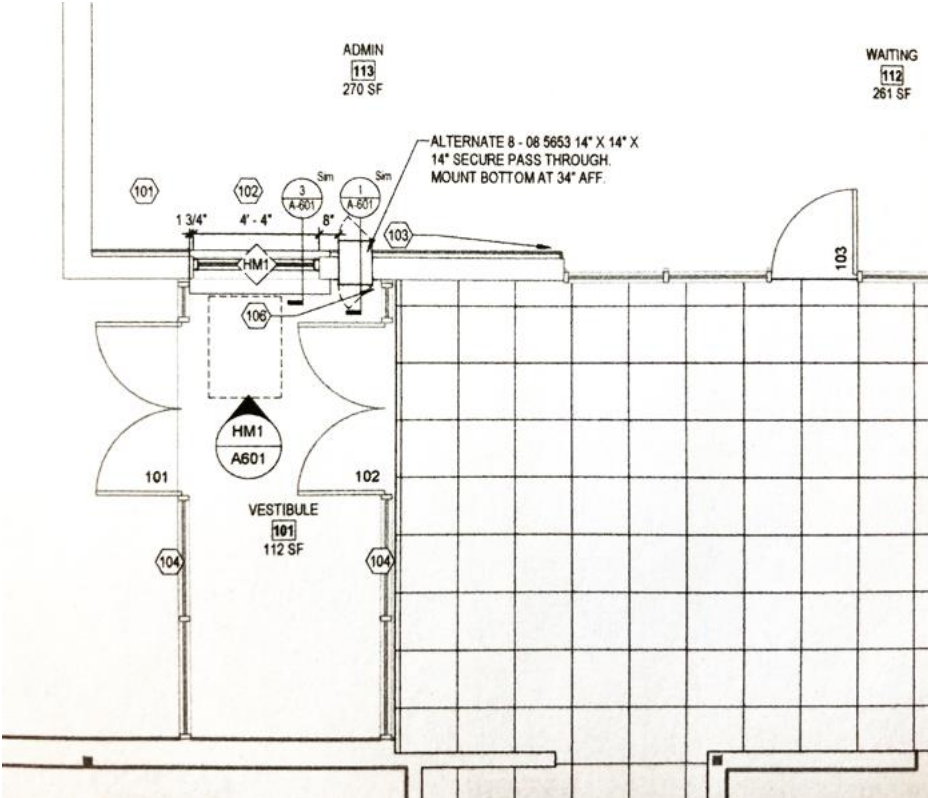

Bradford South – Efficiency Future Ready MOA – TBD

Bids
11/30

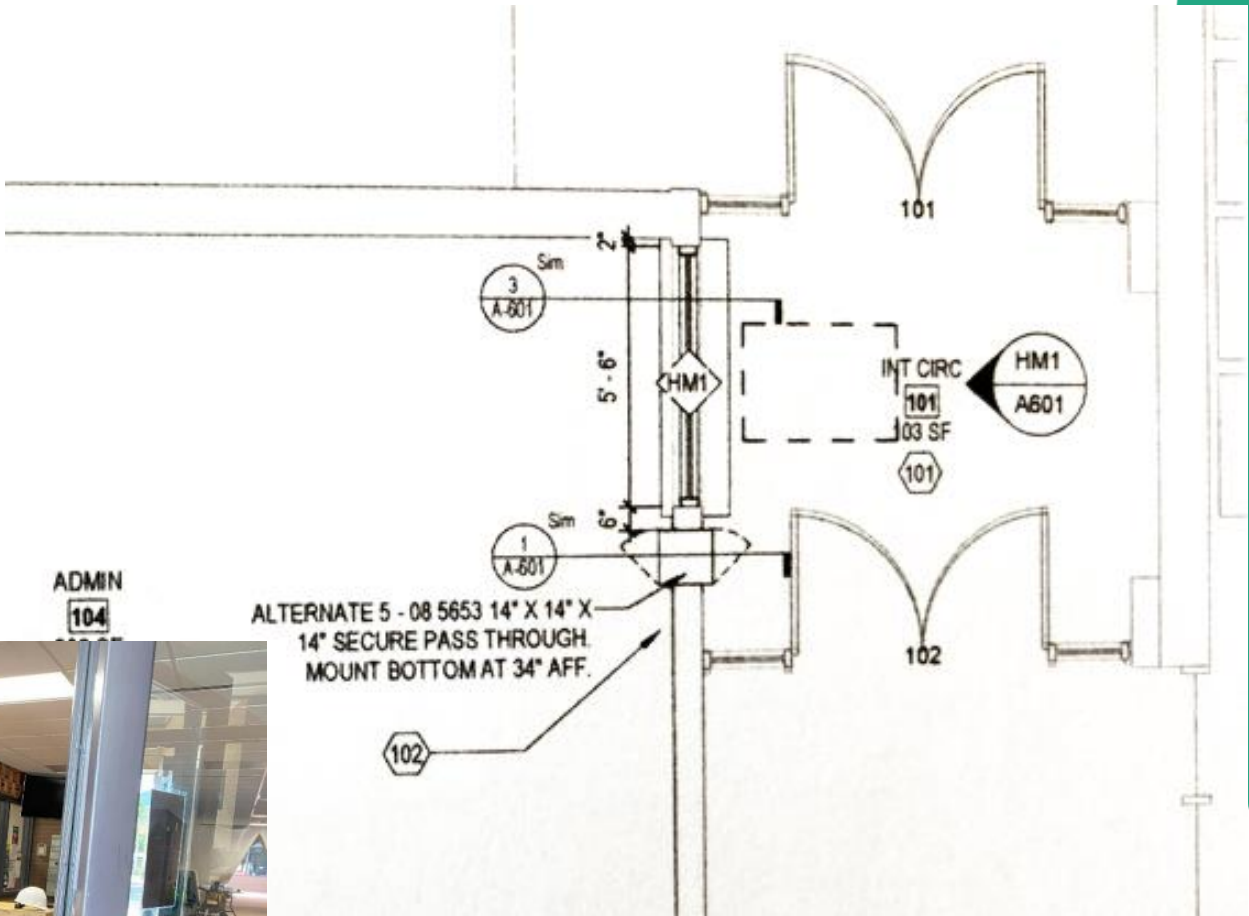

DW Mechanical 2023 Bradford South (RTU's, Controls), Columbine – CMGC Himmelman

Air Handlers have been delivered

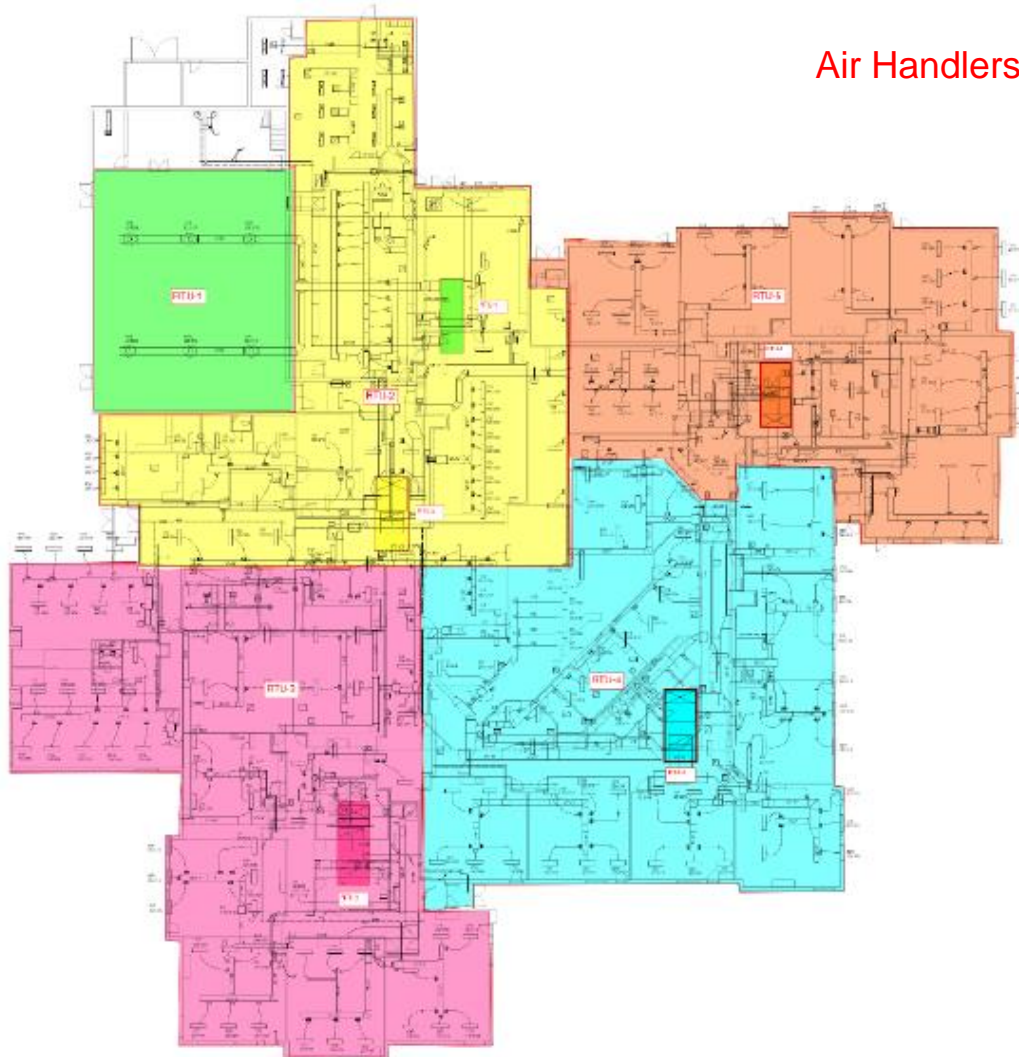

Free Horizon – Efficiency Future Ready HCM – TBD

Bids
12/12

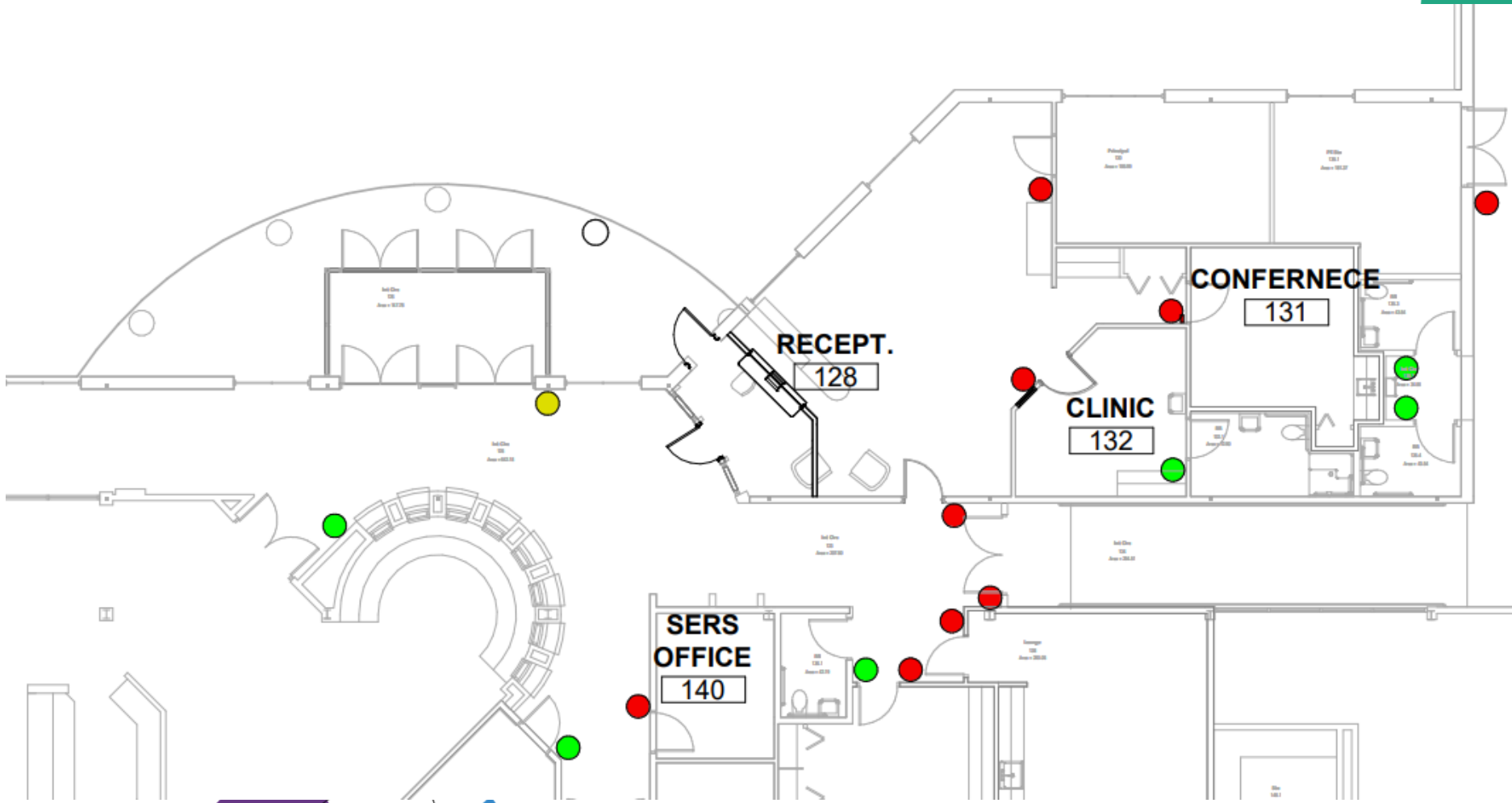

McLain HS – Efficiency Future Ready Eidos – TBD

Bids
12/14

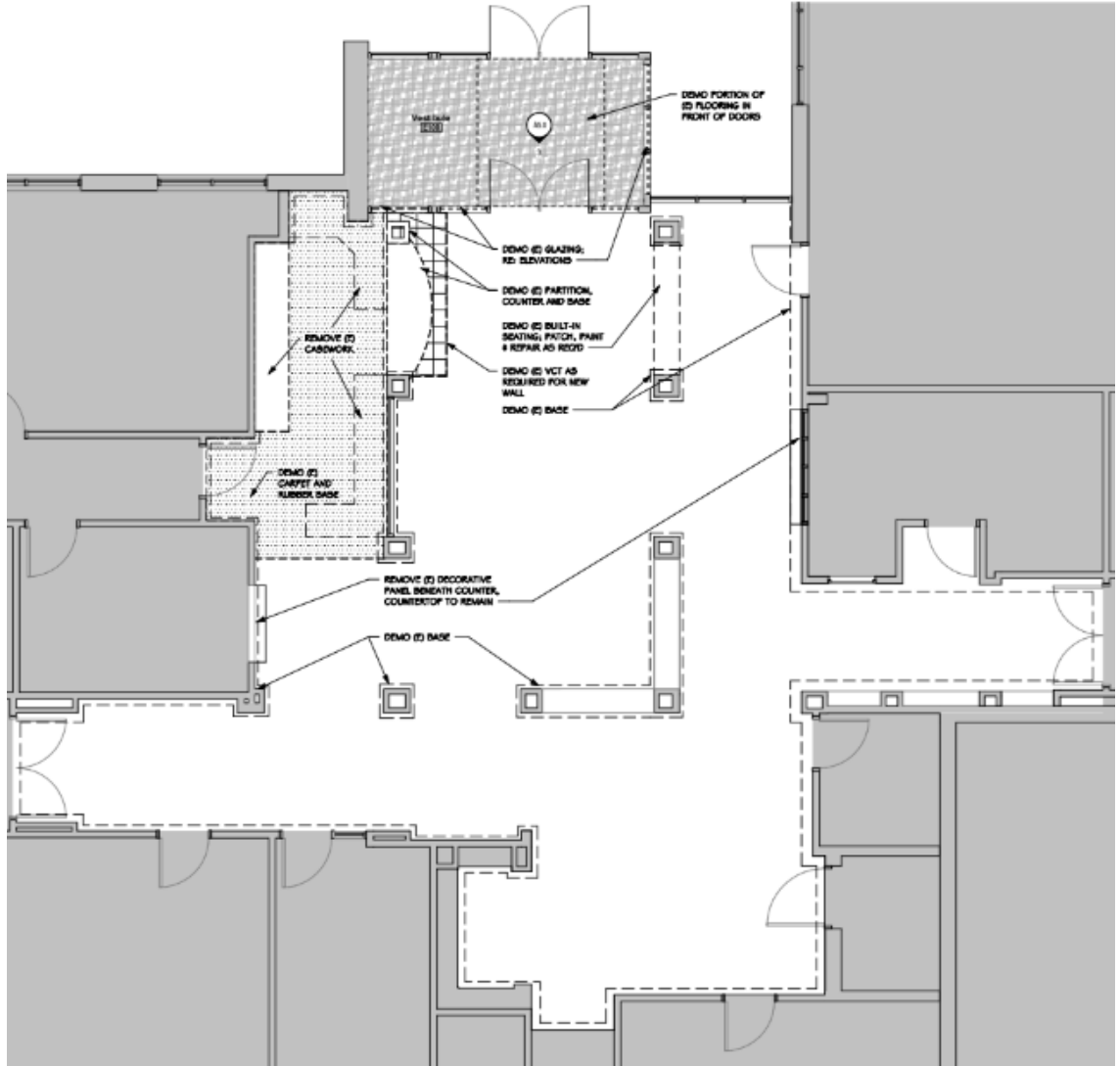

Rooney Ranch ES – Efficiency Future Ready Eidos – TBD

Bids
12/14

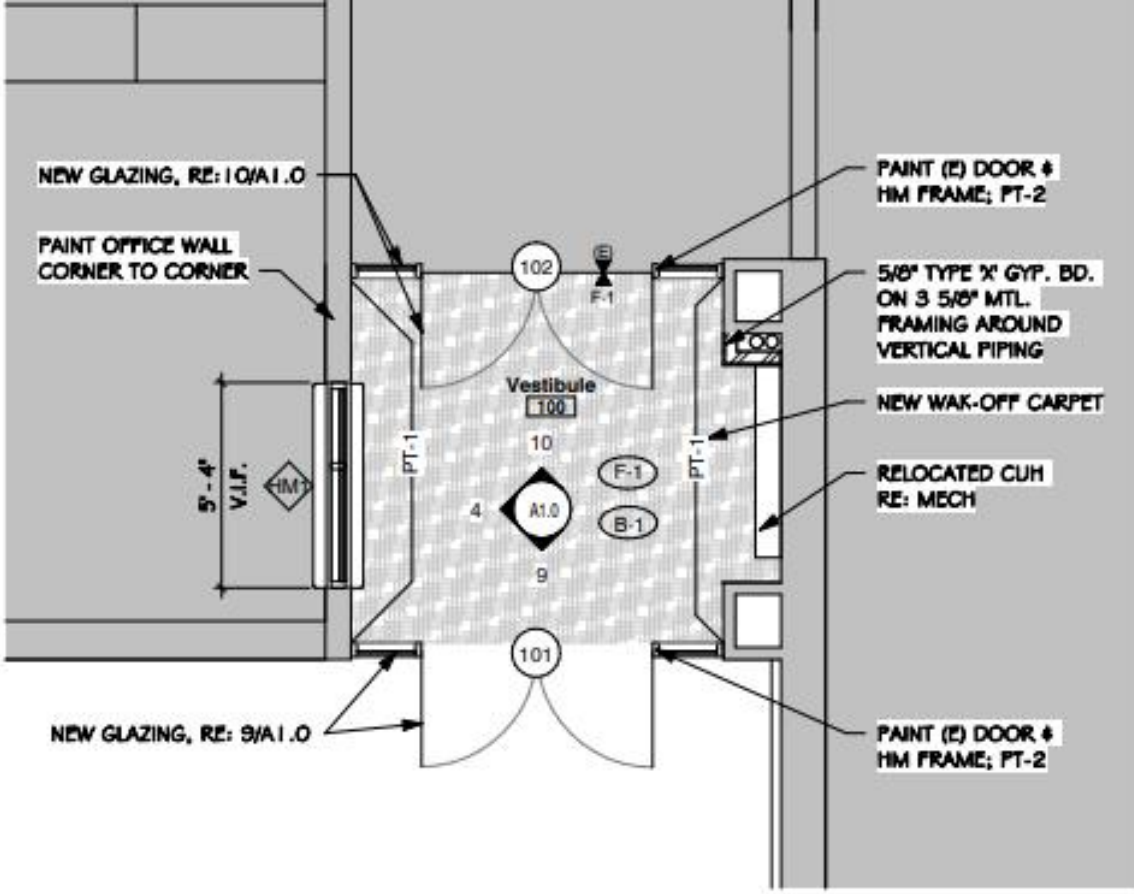

2. Main Level Floor Plan

1/4" = 1'-0"

1'-6"

1'-6"



Leawood ES – Efficiency Future Ready MOA – TBD

Bids
12/20

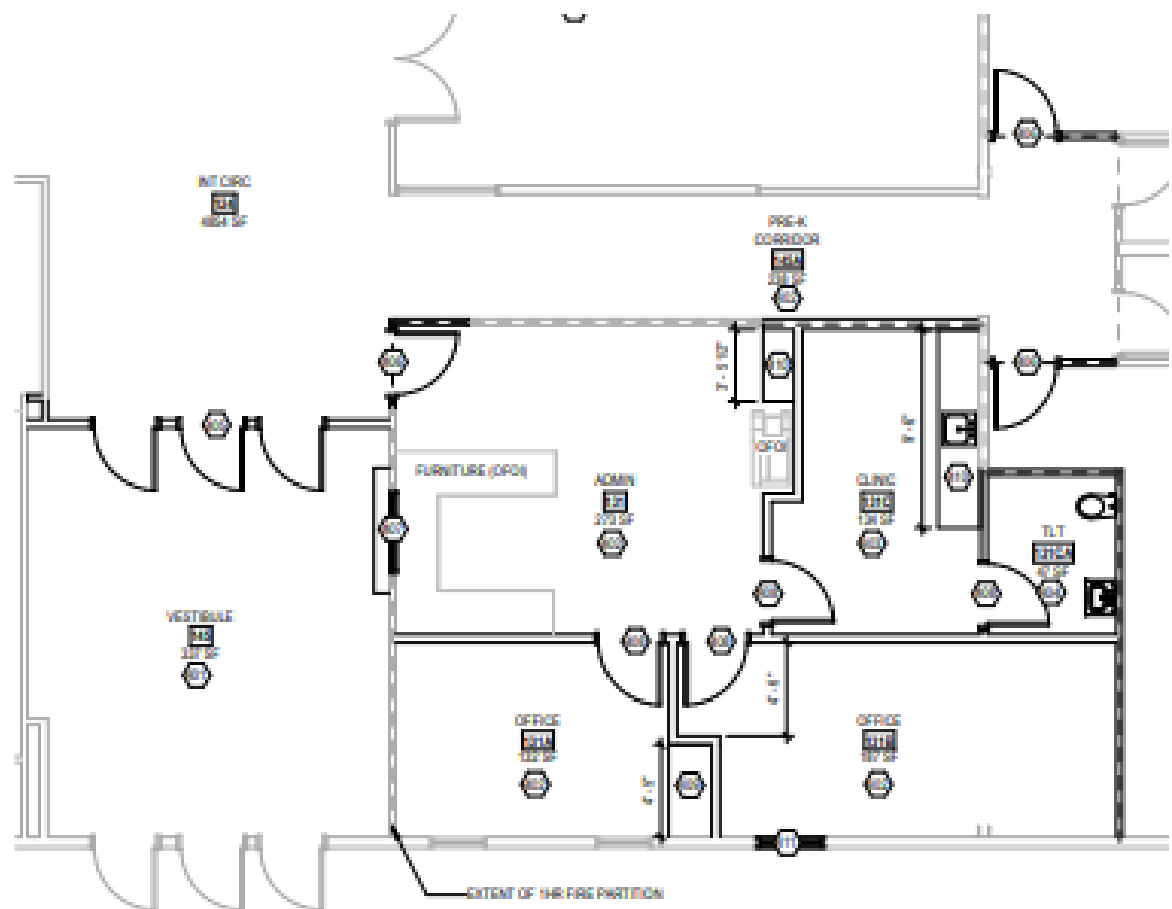

Normandy ES – Efficiency Future Ready MOA – TBD

Bids
12/20

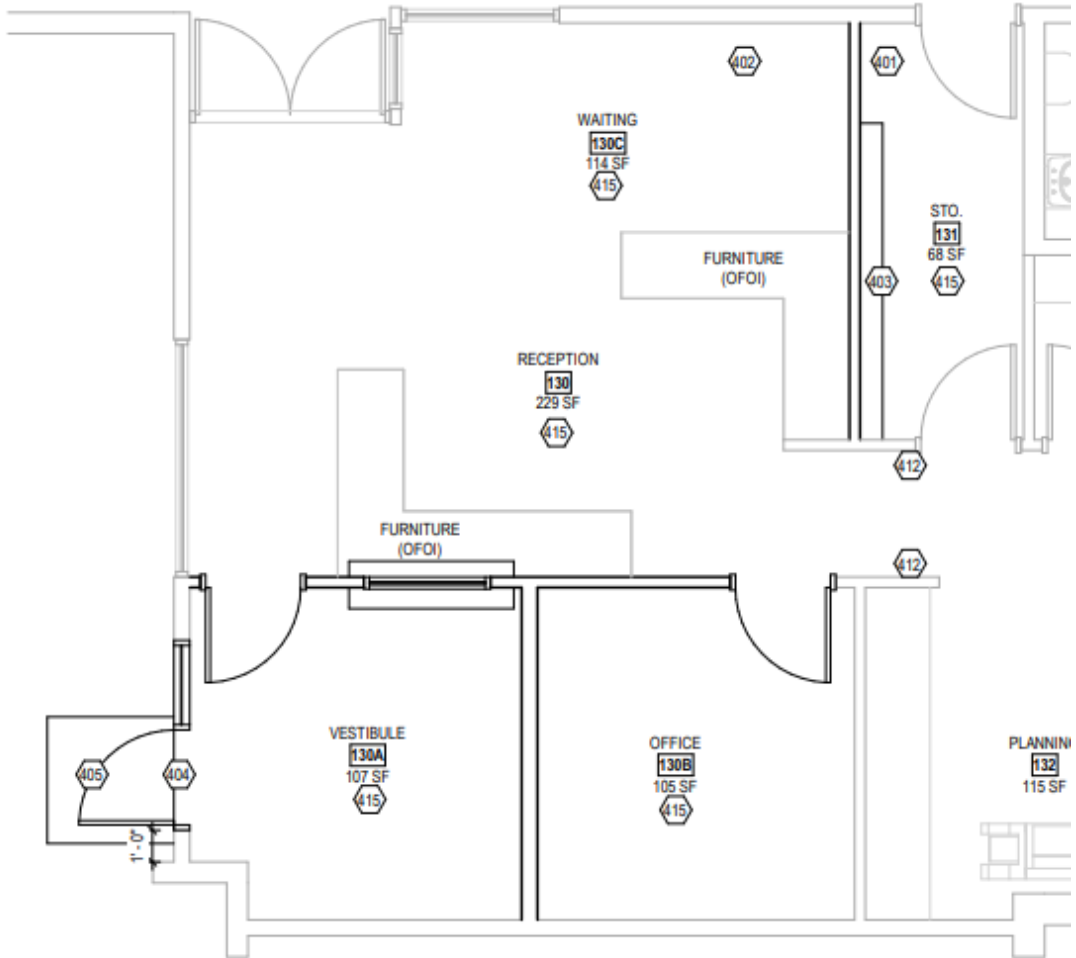

Columbine Hills ES – Secure Entry RB+B – TBD

Bids
2/8

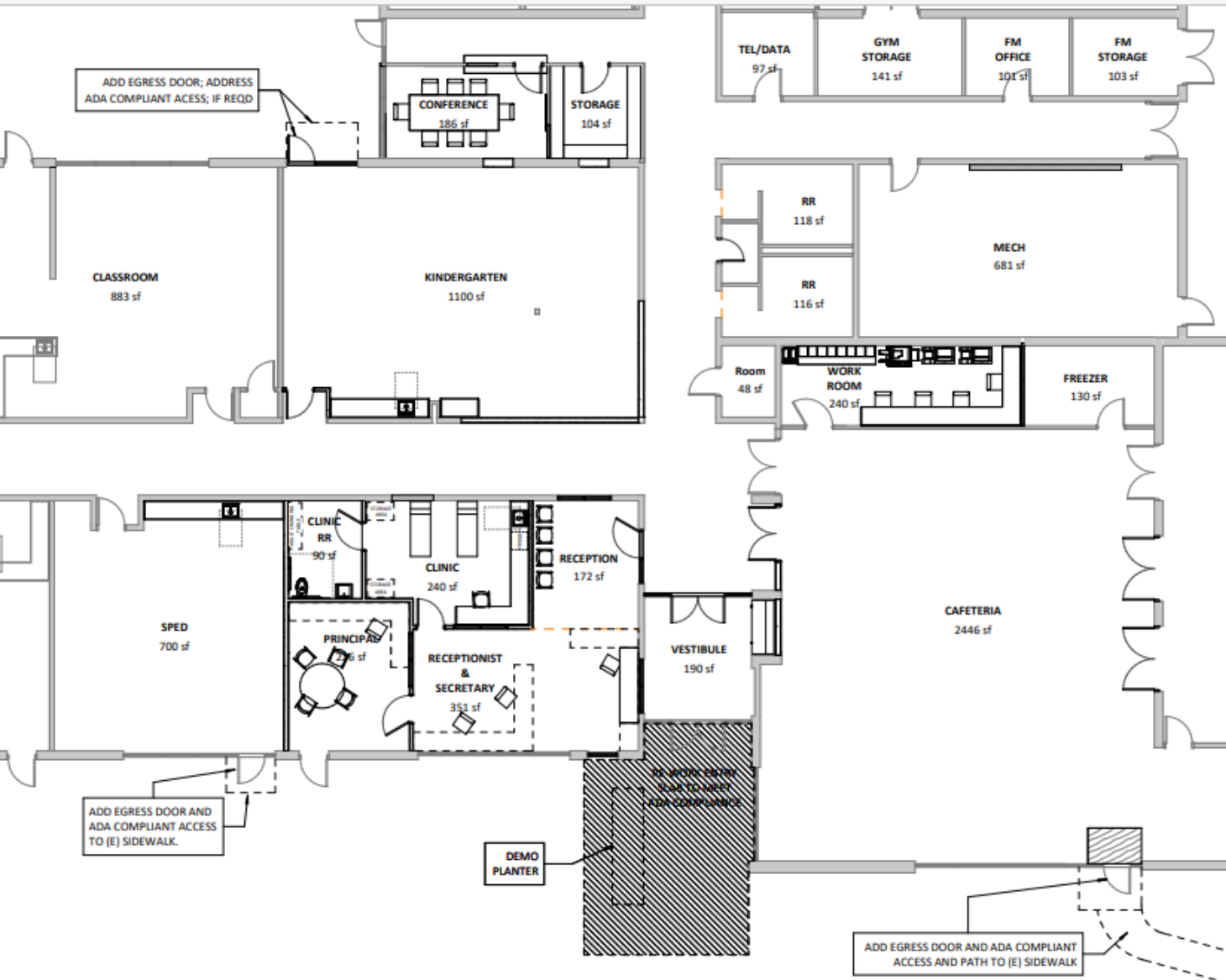

Warren Tech Central Efficiency Future Ready HCM – TBD

Re-Bid TBD
HOLD

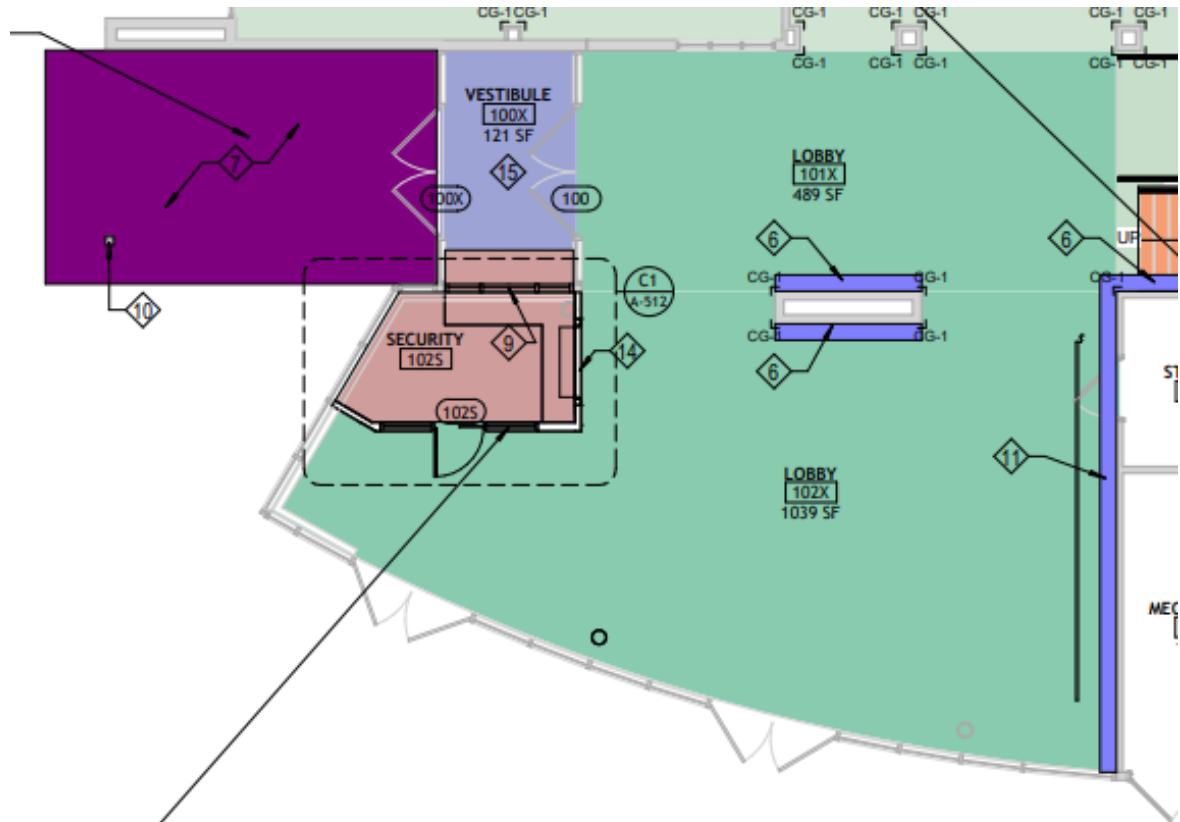

Security Glass Installation

Adams	McLain
Arvada West HS	Mount Carbon Elementary
Bell Middle	Normandy
Belmar	Ralston Elementary
Bradford North	Rooney Ranch
Bradford South	Semper
Deane	Three Creek K-8
Devinny	Wayne Carle MS
Evergreen High	West Woods Elementary
Fairmount	Wilmot
Long View High	
Lukas	
Manning	



DW LED 2024 Ackerman

Design Development



1. Alameda International Jr./ Sr.
2. Hackberry Hill Elementary
3. Manning Option School
4. Conifer High
5. Bear Creek High
6. Lakewood High
7. Belmar Elementary
8. Coronado Elementary
9. Jefferson Jr./Sr. High
10. Standley Lake High
11. Lukas Elementary
12. Ralston Valley High
13. Warren Tech North
14. Wayne Carle Middle
15. Dutch Creek Elementary

FF&E 2024

Bergen Valley ES FF&E

Edgewater ES FF&E

Falcon Bluffs MS FF&E

Long View HS FF&E ()

South Lakewood ES FF&E

Westridge ES FF&E

Evergreen HS FF&E

Oberon MS FF&E ()

Mandalay MS FF&E

Stober MS FF&E



2025 Bond Projects

Chatfield HS FF&E (2023)

Drake MS FF&E (2024)

Normandy ES FF&E ()

Pennington ES FF&E ()

Secrest ES FF&E ()

Stevens ES FF&E ()

Swanson ES FF&E (2024)

Ute Meadows ES FF&E

Van Arsdale ES FF&E (2024)

Warder ES FF&E ()

Westgate ES FF&E ()

West Woods ES FF&E

***Timing and construction are dependent on development and population growth.**

***2018 Bond Program & 6-Year Capital Improvement Plan (Flip Book)**

Location	Description	Bond Scope
Leyden Rock	New School Golden	\$ 21,336,000.00
West Lakewood	New School Morrison	\$ 22,402,800.00

RFQ for Design Services – Ready to Advertise

NOTICE TO ARCHITECTS

Jefferson County School District R-1 (Jeffco) is soliciting qualifications for Architects for a New K-8 School.

Project: New K-8 School
Services: Full Design Services
Anticipated Construction Budget: \$22,402,800

Submittal:

- Proposal Information:** Mail or hand deliver three (3) hard copies and one (1) flash-drive with Adobe.pdf file of all information in hard copy of the completed pre-qualifications form to ensure it is received no later than 4:00 PM, Thursday, Oct 26, 2023. See Request for Qualifications for format and information required.
- Interview:** This Notice is for a specific project. The submittals will be evaluated and the design teams will be selected for an interview process.
- Fee:** Will be negotiated after selection.
- Questions:** Forward questions in writing to the attention of:
 Ed Huszco, Senior Project Manager Construction Management.
 Email edward.huszco@jeffco.k12.co.us
- It is strongly advised that all interested parties review the District's Architect Agreement and be prepared to sign the agreement without modification if selected for the project. The Architect Agreement can be downloaded from the same website listed above.
- Consultant may be asked to provide Compliance with appropriate sections of the district's Consultant Guidelines.
- In the upper left-hand corner of the envelope provide a label with the following:

[Name of Company Submitting Qualifications]
NEW K-8 SCHOOL
Statement of Qualifications
Jefferson County School District R-1

- Address the information to the attention:
Facilities Department
 c/o Tim Reed, Executive Director of Facilities and Construction Management
 Jefferson County School District R-1
 809 Quail Street, Building #4
 Lakewood, CO 80215Golden, Colorado 80401



2023 Policy Projects

Regional Opportunities for Thriving Schools – BOE Nov 10, 2022

Capital Investments for Thriving Schools - BOE Jun 08, 2022

Healthy & Equitable Start Times - BOE Mar 03, 2022

School Closings & Consolidations

Resolution: Board of Education Decision on Staff
Recommendation Regional Opportunities for Thriving Schools
Thursday, November 10, 2022

Construction
Complete
Q1 2024

Stober ES (5CR Addition + Kitchen) LOA & CMGC GTC



School Closings & Consolidations

Resolution: Board of Education Decision on Staff
Recommendation Regional Opportunities for Thriving Schools
Thursday, November 10, 2022

Construction
Complete
Q1 2024

Stober ES (5CR Addition + Kitchen) LOA & CMGC GTC



School Closings & Consolidations

Resolution: Board of Education Decision on Staff
Recommendation Regional Opportunities for Thriving Schools
Thursday, November 10, 2022

Bergen Valley ES - EUA & GC Crossland



School Closings & Consolidations

Construction

Resolution: Board of Education Decision on Staff
Recommendation Regional Opportunities for Thriving Schools
Thursday, November 10, 2022

Bergen Valley ES - EUA & GC Crossland



6-12 Reconfiguration Pomona HS HCM – TBD

Bids
November 16

BOE Jun 22, 2023 - Regular Meeting

- a. Effective July 1, 2024, Moore Middle School will close; and
- b. The Moore Middle School and Pomona High School boundary attendance areas will be combined; and
- c. Pomona High School will be reconfiguring into a 6-12 school;

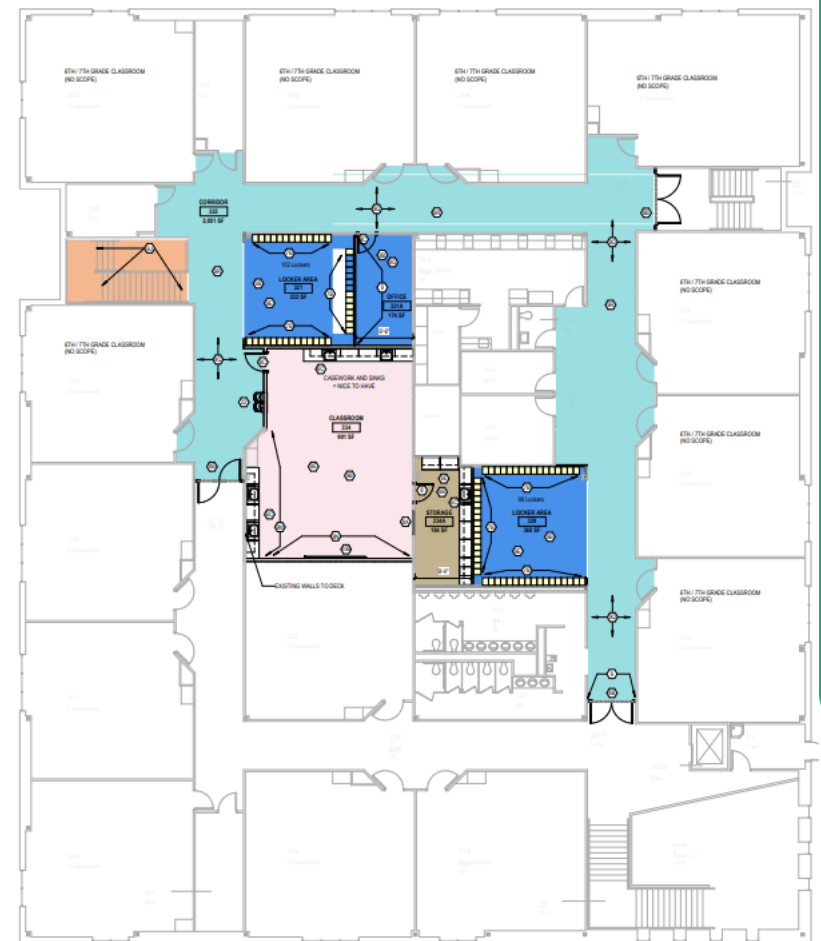

6-12 Reconfiguration Pomona HS HCM – TBD

Bids
November 16

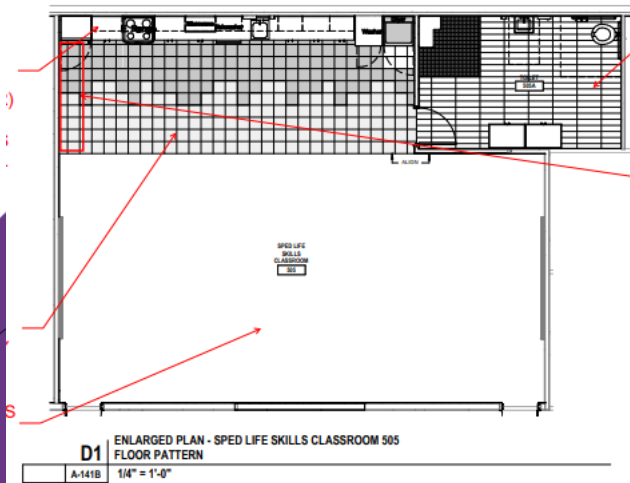
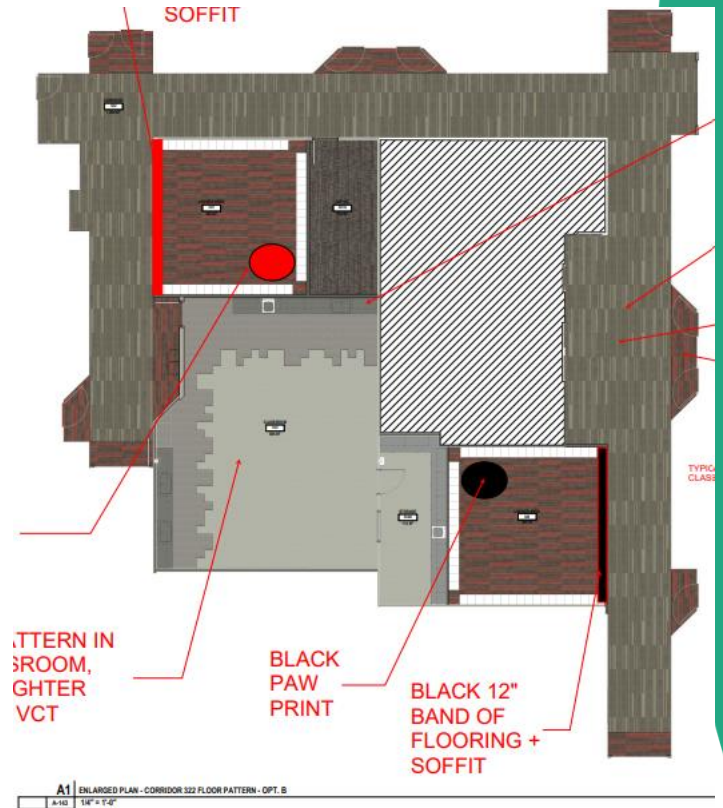
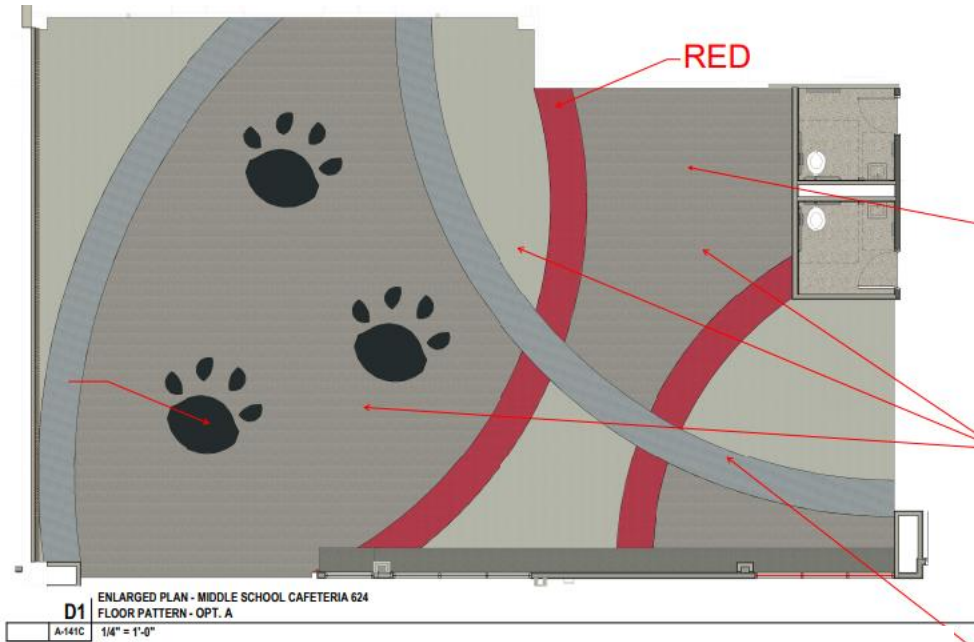

Healthy & Equitable Start Times

Start Times Next Steps

BOE Mar 03, 2022

High School Athletic Fields – Temp Lighting

Engineer Ackerman – CMGC Himmelman

Address challenges related to athletics and activities.

Sites - update 11/13:

5A	
Columbine High School	#2
Ralston Valley Senior High School	#5
Chatfield High School	#14
4A	
Dakota Ridge	#7
3A	
Green Mountain High School	#1

Fletcher Miller Special School New Facility @ Current Site

Design
Development

MOA – GC TBD

BOE Jun 07, 2023 - Special Meeting-Study/Dialogue Session
Funding TBD Fall 2023



Fletcher Miller Special School New Facility @ Current Site

Design
Development

MOA – GC TBD

BOE Jun 07, 2023 - Special Meeting-Study/Dialogue Session
Funding TBD Fall 2023



Fletcher Miller Special School New Facility @ Current Site

Design
Development

MOA – GC TBD

BOE Jun 07, 2023 - Special Meeting-Study/Dialogue Session
Funding TBD Fall 2023



Fletcher Miller Special School New Facility @ Current Site

Design
Development

MOA – GC TBD

BOE Jun 07, 2023 - Special Meeting-Study/Dialogue Session
Funding TBD Fall 2023



Arvada K-8 Closure Implications North Arvada MS

Eidos – TBD

Schematic
Design
Estimate
\$410,164

BOE Oct 12, 2023 – Regular Meeting

Effective July 1, 2024, Arvada K-8 will close and combine its boundary with Lawrence Elementary school for grades K-5 and with North Arvada Middle school for grades 6-8.

BOE Aug 24, 2023 - Special Meeting- Study/Dialogue Session

Regional Opportunities for Thriving Schools Phase II
October 12: Board of Education vote. Closure Arvada K8

North Arvada Middle School - (evaluate apx. 13 rooms) may need minimal, one-time facilities modifications in the range of \$300-500K in order to move existing programs to welcome new boundary students.



Arvada K-8 Closure Implications Lawrence ES

Schematic Design

Eidos – TBD

BOE Oct 12, 2023 – Regular Meeting

Effective July 1, 2024, Arvada K-8 will close and combine its boundary with Lawrence Elementary school for grades K-5 and with North Arvada Middle school for grades 6-8.

BOE Aug 24, 2023 - Special Meeting- Study/Dialogue Session

Regional Opportunities for Thriving Schools Phase II
October 12: Board of Education vote. Closure Arvada K8

Lawrence Elementary - (evaluate ap. 14 Rooms / Storage Needs) may need minimal, one-time, facilities modifications in order to welcome new boundary students, comparable to modifications made to similarly-sized elementary schools welcoming students as part of Phase I of ROFTS at a cost of ~\$675K

Lawrence ES Renovations

October 16, 2023



1. Main Level Floor Plan SD

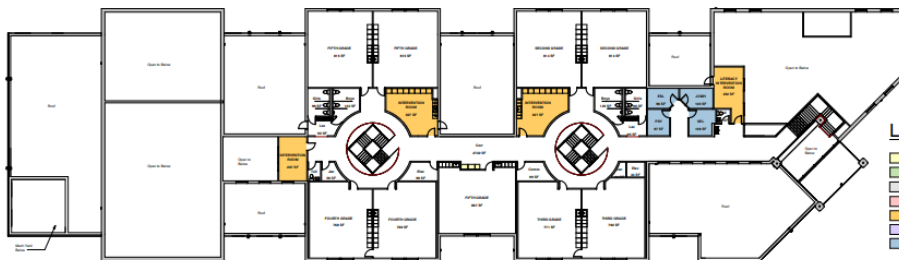

2. Upper Level Floor Plan SD

LEGEND

- Adult Storage Cabinets
- Conference Room
- Copy Room
- Holding Stations
- Intervention Rooms
- Music Spaces
- Offices



2024 General Capital Projects

Stride Clinic @ Alameda International Jr/Sr High

Construction

Jordin – Haselden

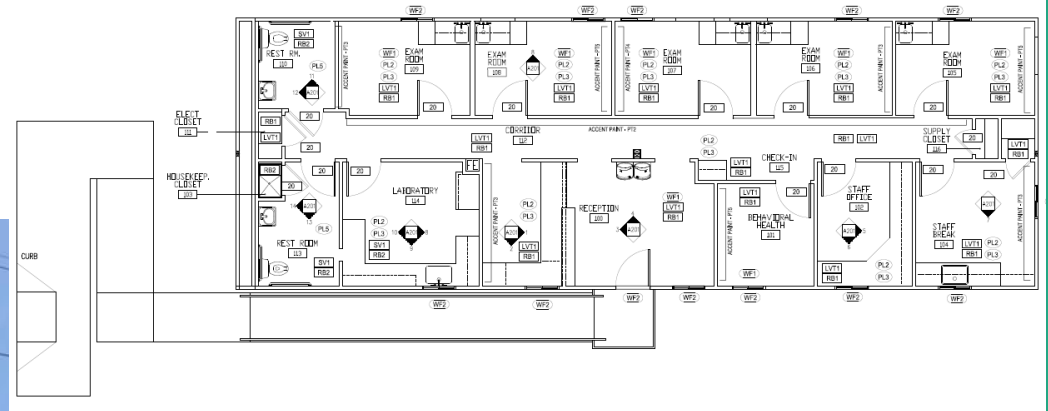

DW FA Upgrades (Voice Evac) D'Evelyn & Pomona TLH Fire – Weifield Group

Construction
Summer 2024



Wayne Carle – Settlement Cracks

RB+B

Monitoring
Devices
installed

Stabilization
work Winter
Break

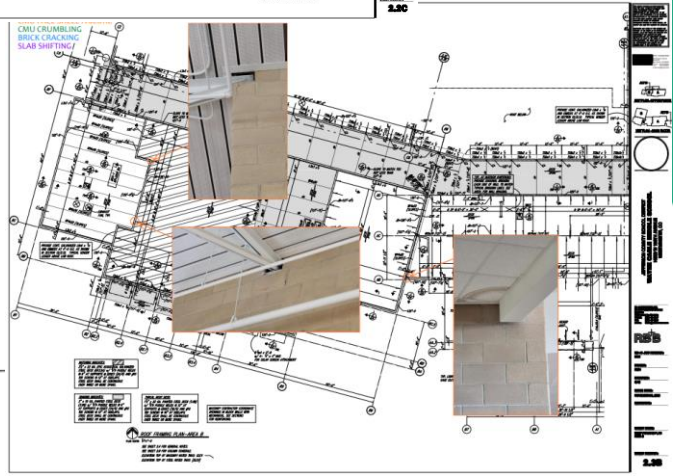
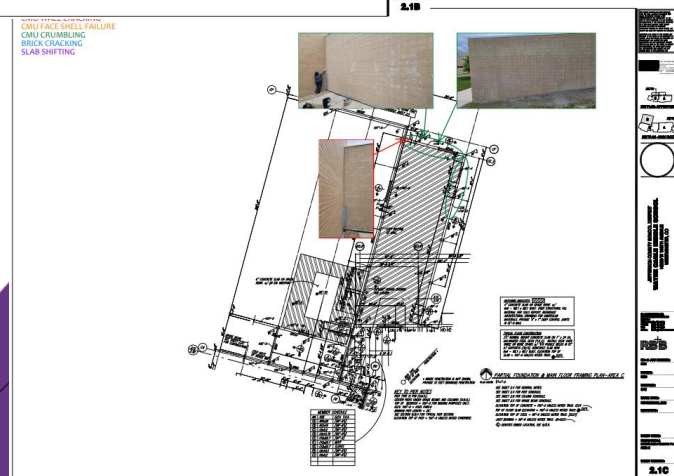
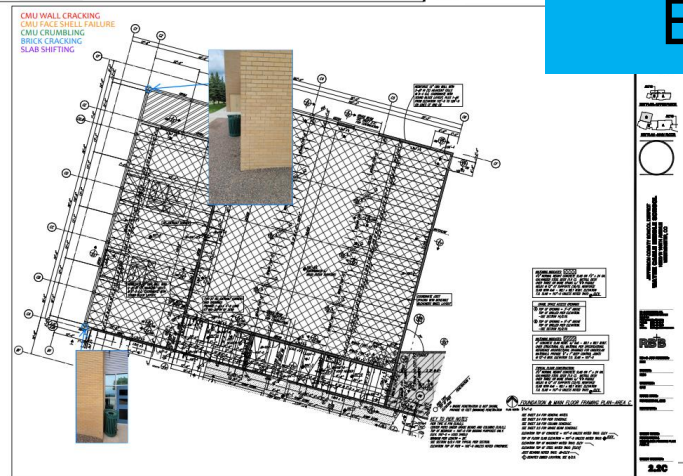
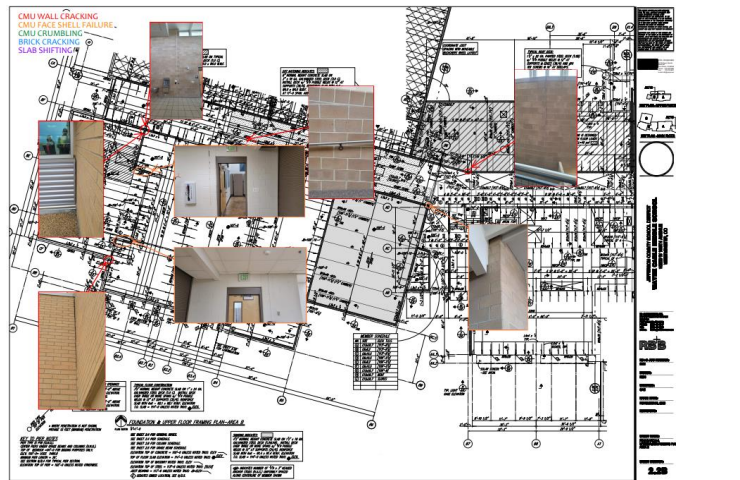

DW Hail Damage – 6 schools Red Rocks, Columbine SHS, Parmalee, Leawood, Blu Heron, Rooney Ranch

Groditski – TBD

Assessment

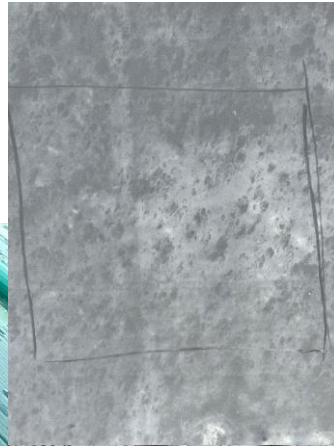
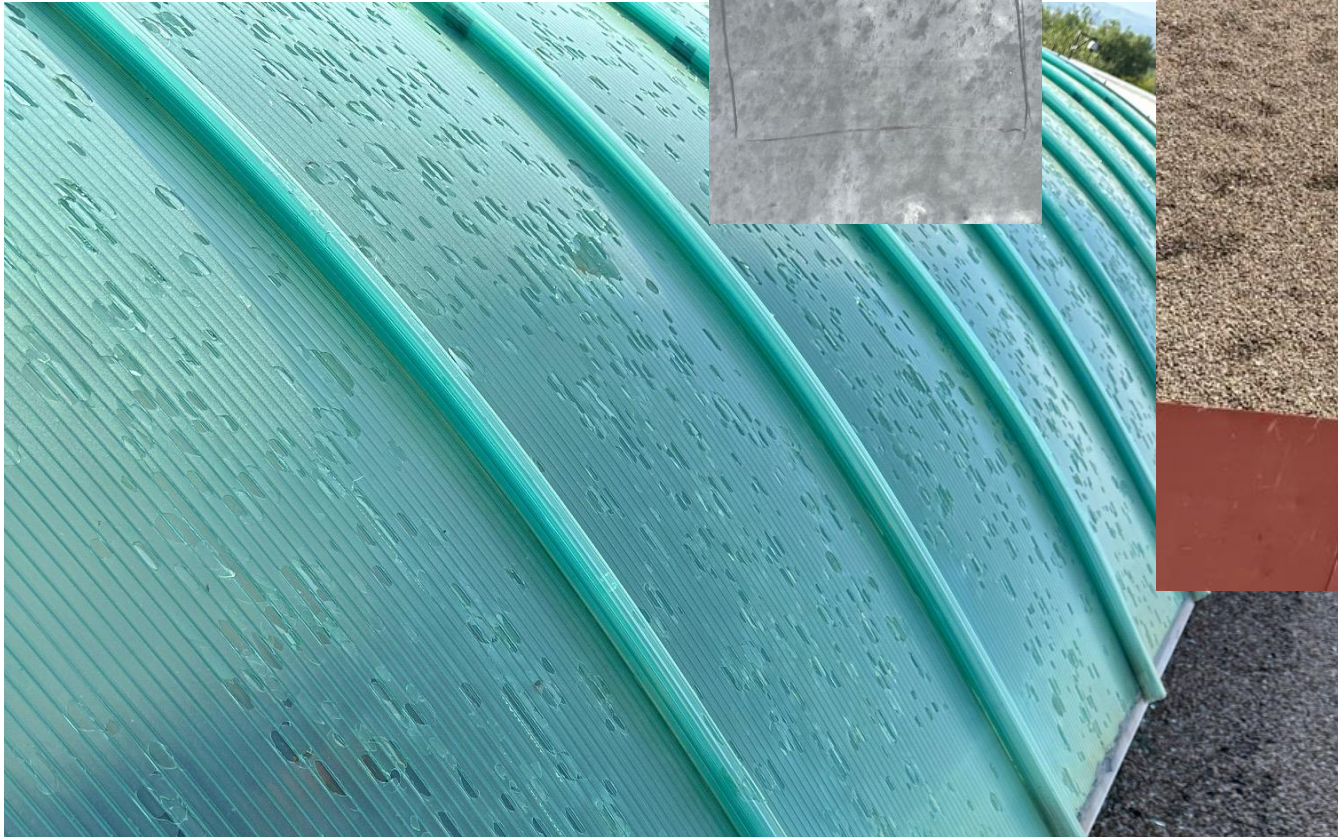

Alameda HS AHU

Schematic Design

Cator Ruma – TBD

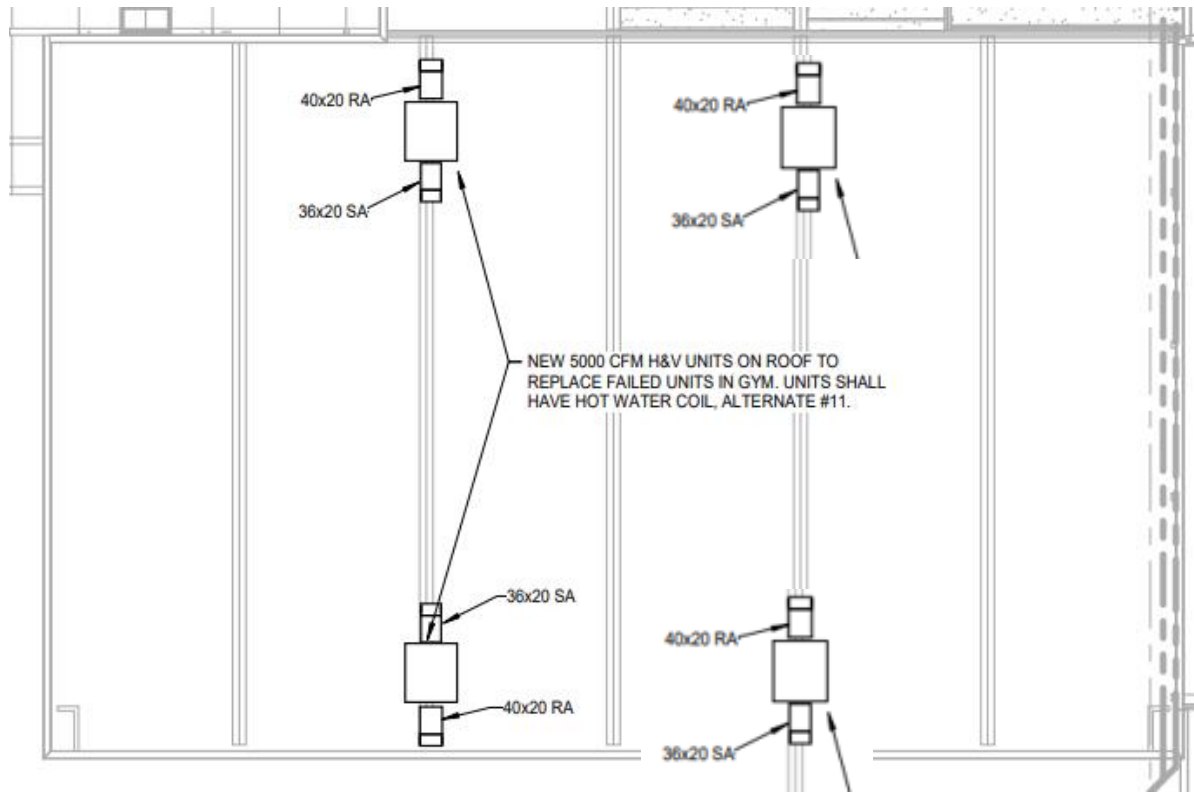

Alameda HS Provide Auditorium Air Conditioning

Cator Ruma – TBD

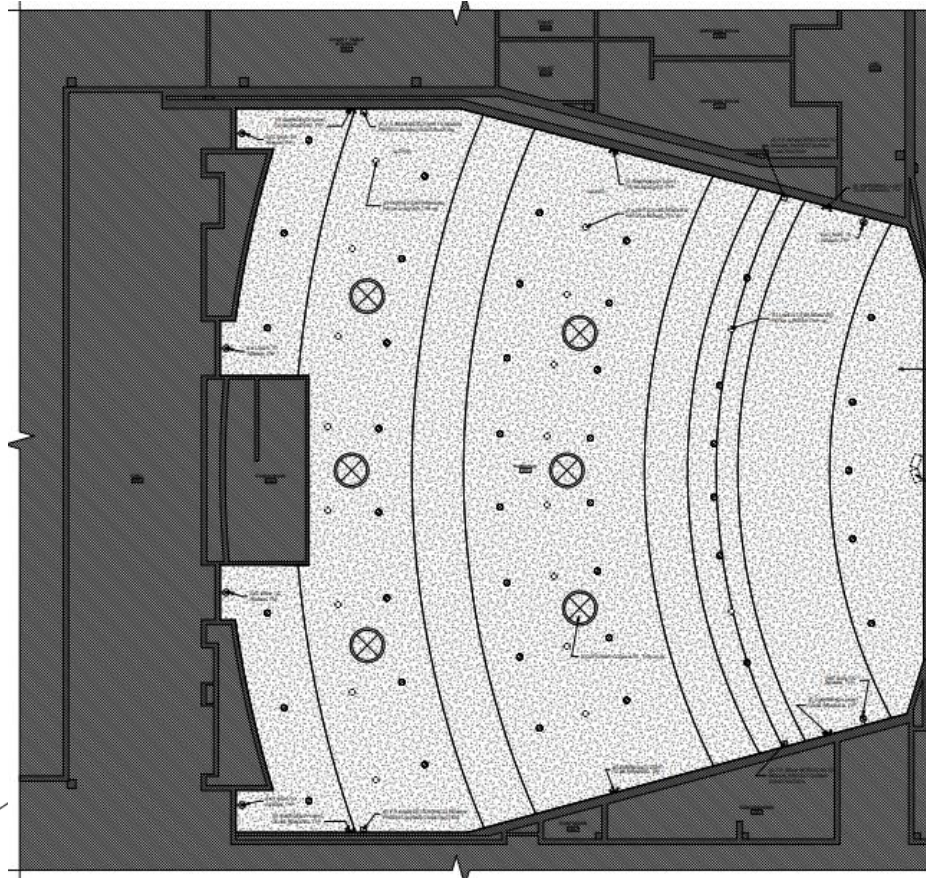

DW FA Upgrades (Voice Evac) Blue Heron TLH Fire – TBD

Schematic
Design



Safety and Security

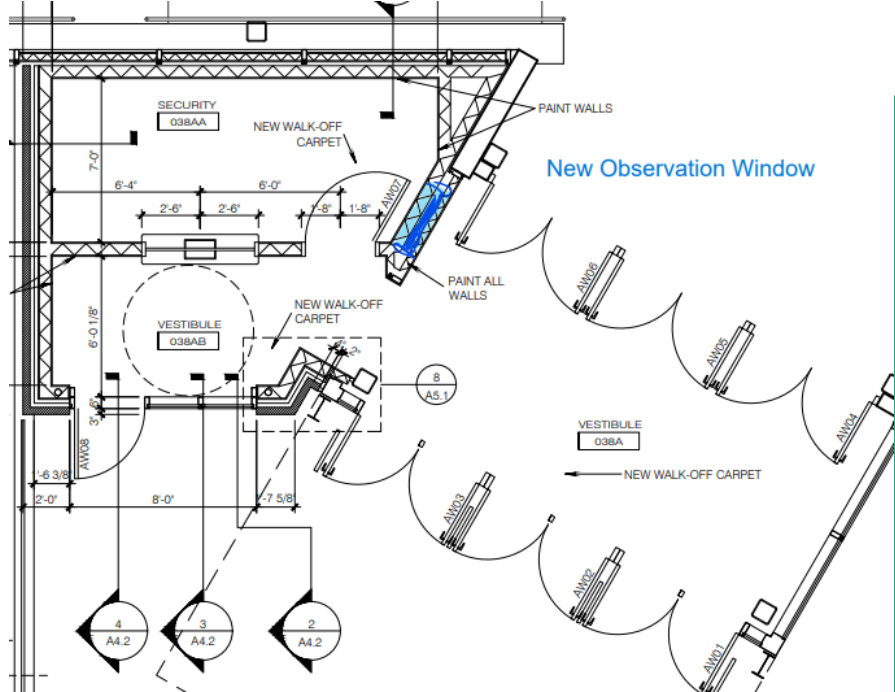

ARVADA WEST HS

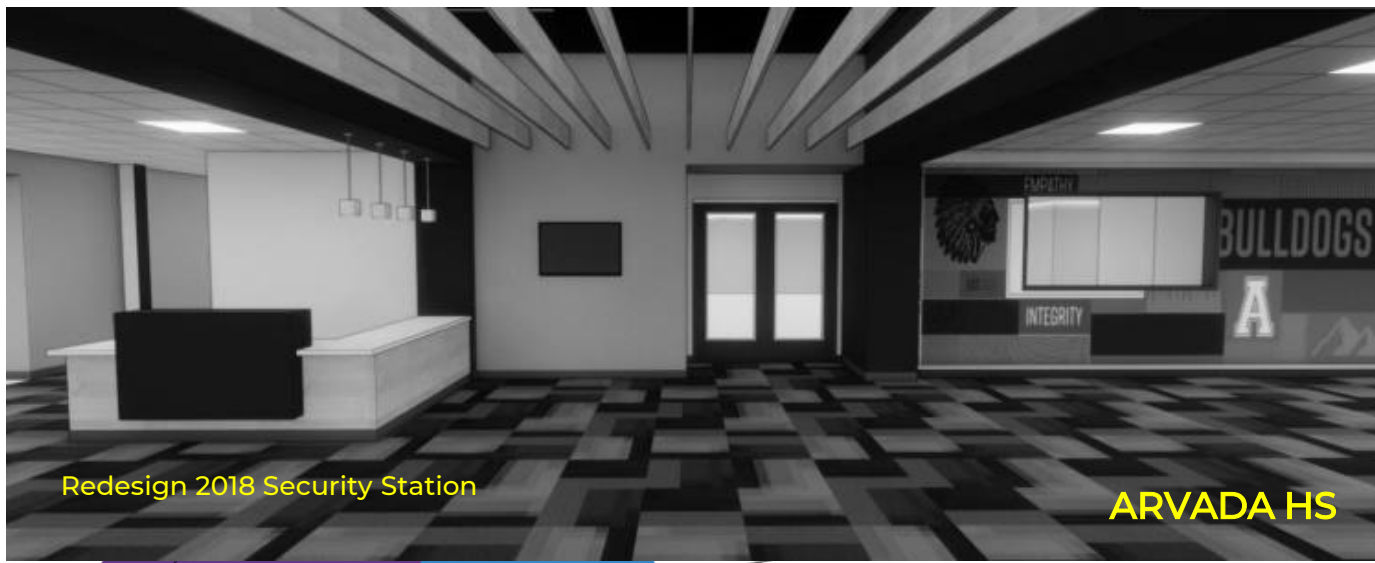

Redesign 2018 Security Station

ARVADA HS

BOE Construction Agenda Items December 14, 2023

Fletcher Miller A/E Contract MOA - *\$2,277,730 (7/7/2023 Proposal)

Pomona 6-12 Reconfiguration GC Contract Bids TODAY – \$1,345,810 (Base Scope Estimate 9/27/23)

Field Lighting GMP Contract - *\$6,900,182 (4/17/23 GMP)

Stober ES Change order to GMP Contract - \$453,109 (PCO 10/24/23)

* Numbers were obtained over 3 months ago (re-verification is occurring)



Next Meeting 12/21/23